

TOWEREZ™ FREE STANDING

DOWNLOAD FULL VERSION FROM RACKSUPPLIER.CO.UK

BOX SET

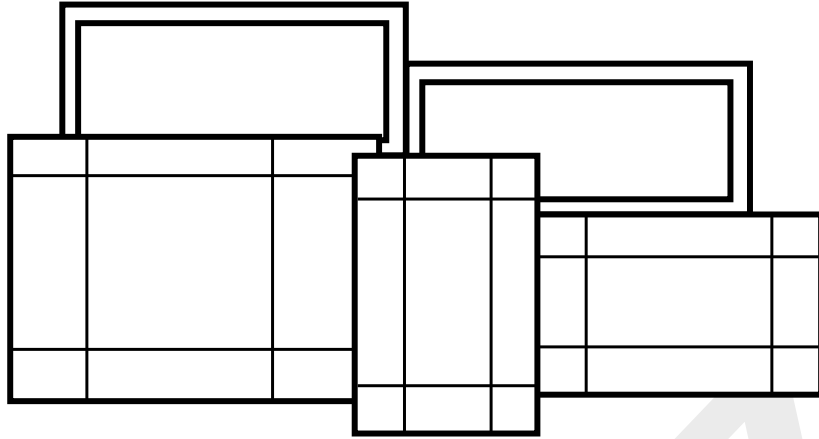

BOX I

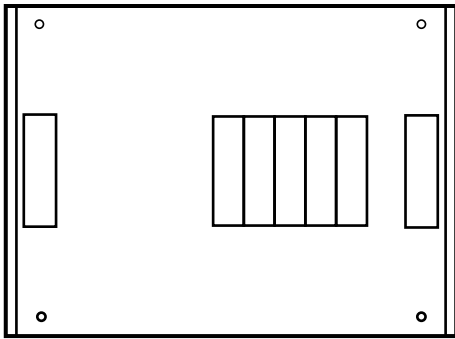

TOP COVER

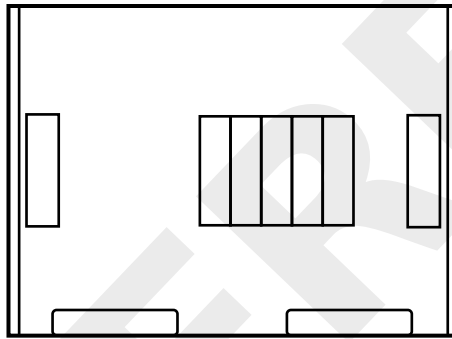

BOTTOM COVER

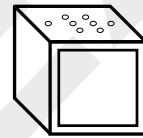

BLACK BLOCKS
(JUST 800 VERSION)

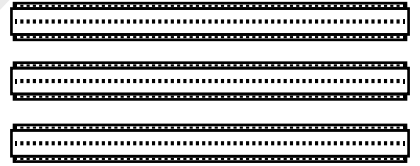

2 (LESS THAN 32U) OR 3 PAIR RAILS (+32U)

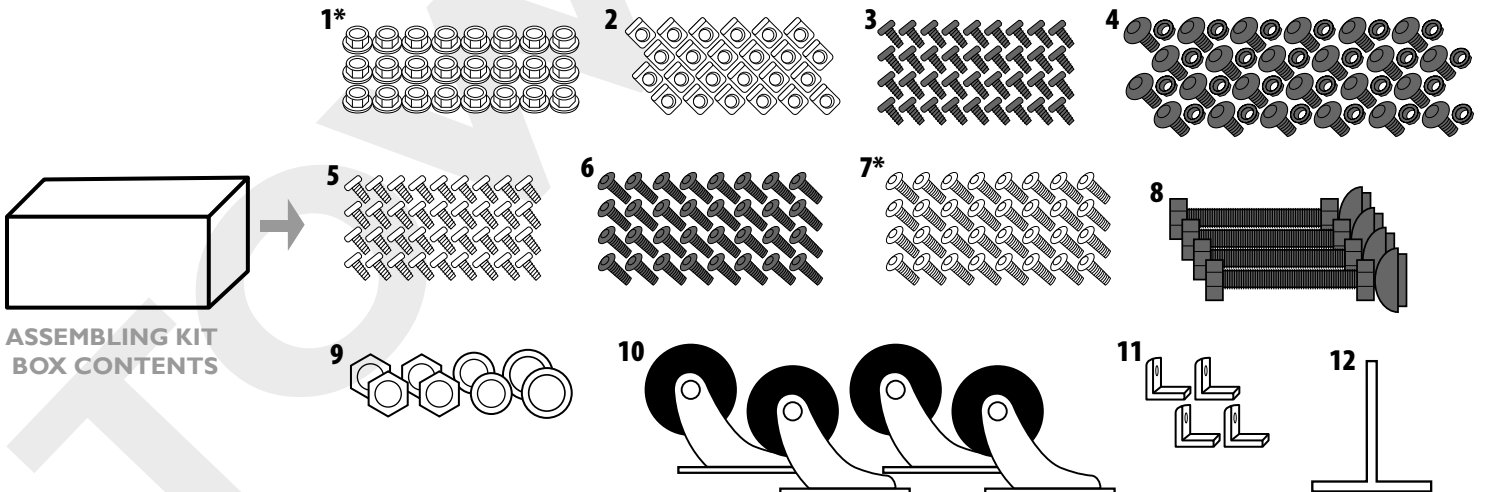

ASSEMBLING KIT
BOX CONTENTS

* USED ON THE 800 VERSION ONLY

BOX 2 AND 3

1X FRAME IN EACH BOX (2 FRAMES IN TOTAL)

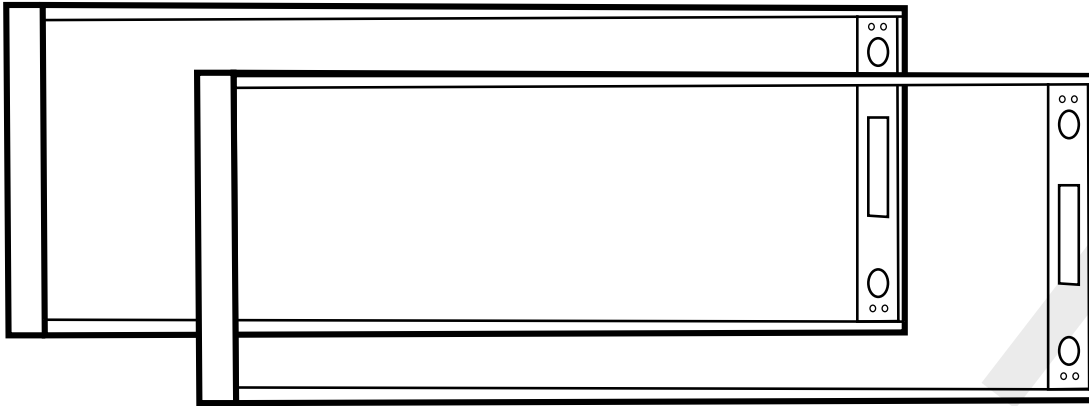

2X SILVER RAILS IN EACH BOX (4 RAILS IN TOTAL)

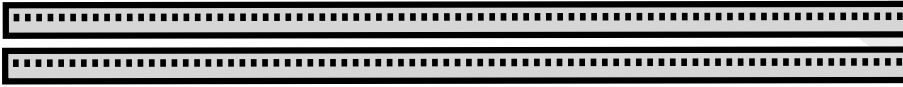

BOX 4

2x DOORS
(GLASS OR MESH)

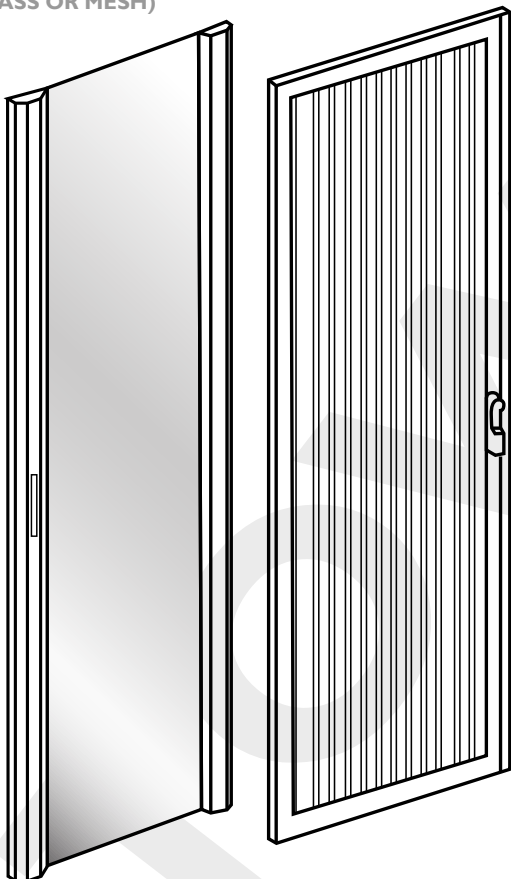

BOX 5

2X SIDE PANELS

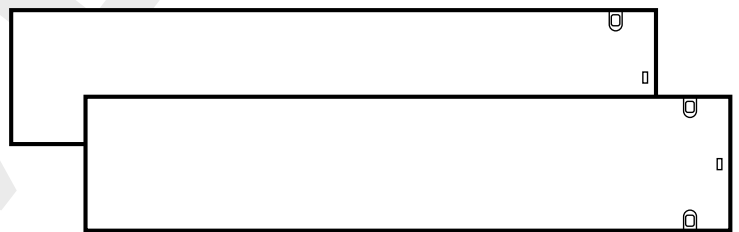

BOX 6

2X CABLE MANAGEMENT (800 WIDE VERSION)

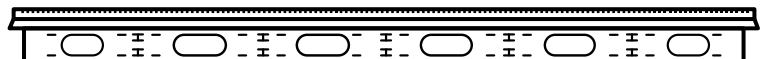

STEP 1

LAY DOWN THE BOTH FRAMES FROM BOX 2 AND 3

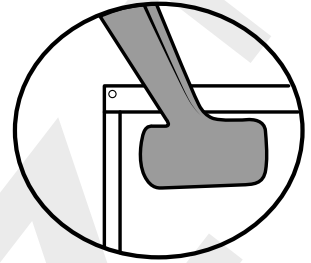
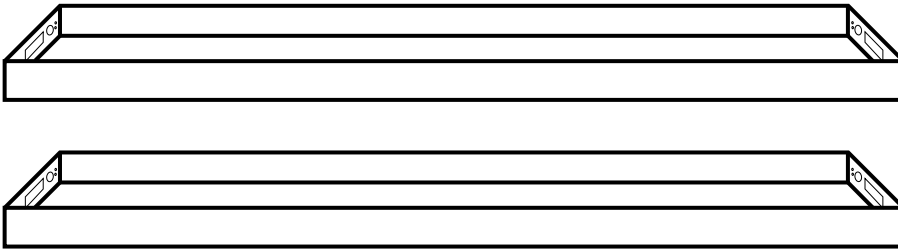

NOTE: YOU MIGHT NEED TO BANG THE CORNERS OUT IN THE TOP AND BOTTOM FRAMES

STEP 2

ATTACH TOP AND BOTTOM COVER TO FRAMES

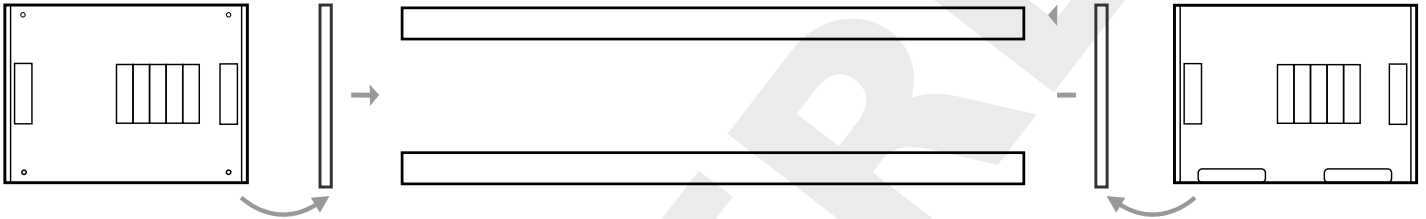

STEP 3

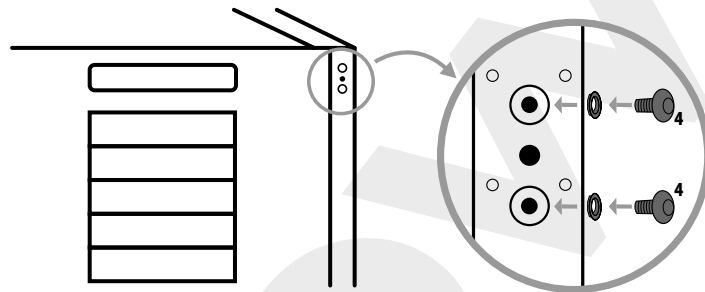

USE 8 SCREWS FOR THE TOP COVER AND 8 FOR BOTTOM COVER

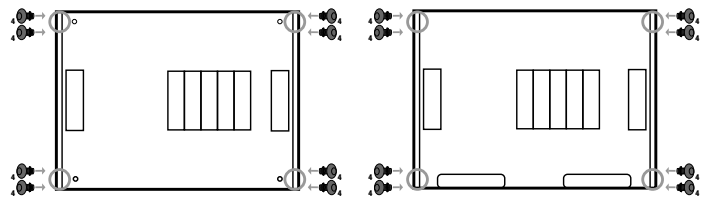

STEP 4

FOR 800 WIDE VERSION USE THE BLOCKS FIRST

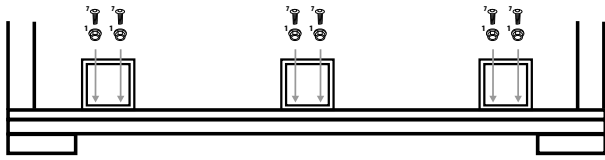

REPEAT THIS PRODEDURE FOR BOTH SIDES, TOP AND BOTTOM, 12 BLOCK IN TOTAL

PUT THE VERTICAL RAILS OVER THE BLOCKS

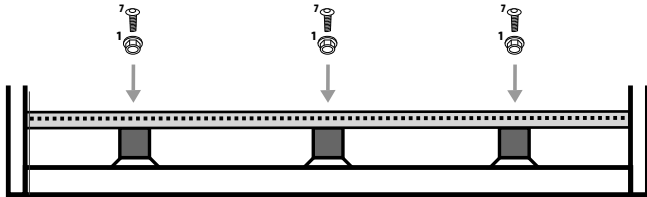
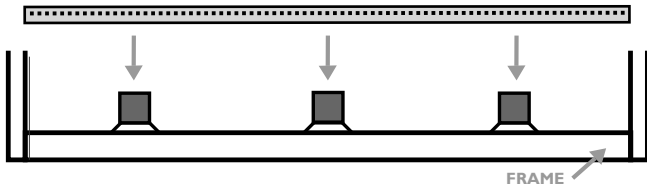

REPEAT THIS PRODEDURE 4 TIMES, 4 VERTICAL RAILS IN TOTAL

ON THE 600 WIDE VERSION ATTACH THE HORIZONTAL RAILS

ATTACH THE SILVER RAILS, 2 OR 3 EACH SIDE, INSIDE THE STRUCTURE

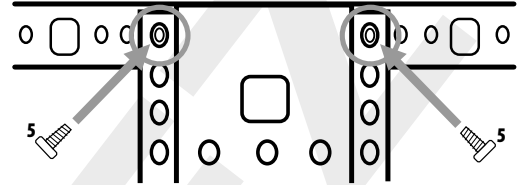
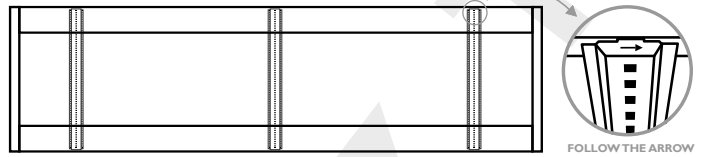

PUT THE VERTICAL RAILS OVER THE HORIZONTAL RAILS

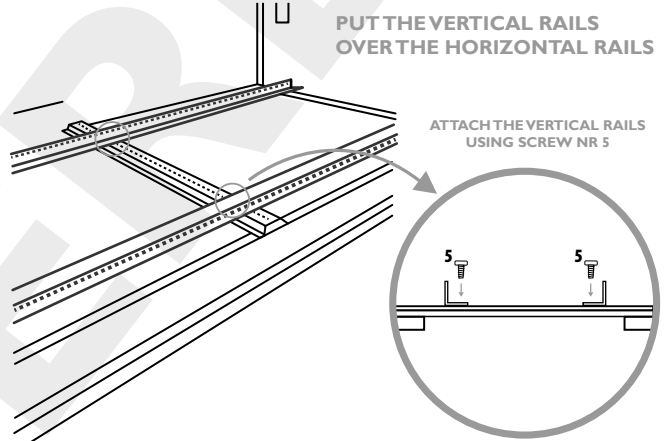

ATTACH THE VERTICAL RAILS USING SCREW NR 5

REPEAT THIS PRODEDURE 4 TIMES, 4 VERTICAL RAILS IN TOTAL

IN THE END, THE FRONT AND BACK SIDE WILL LOOK LIKE THIS

800 WIDE VERSION

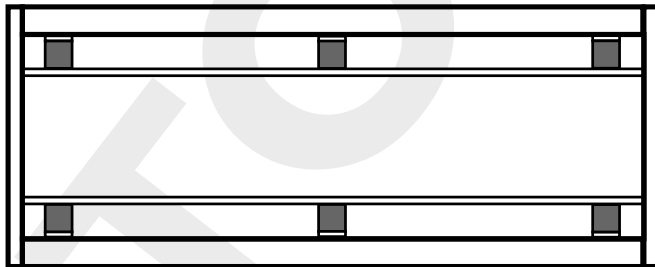

600 WIDE VERSION

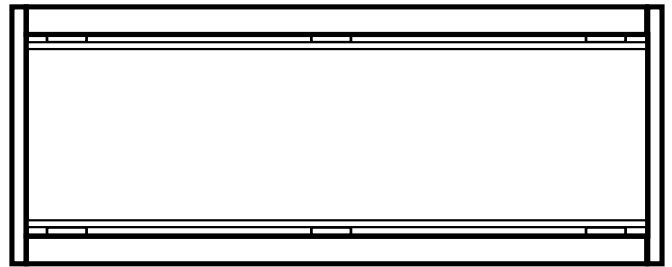

STEP 5

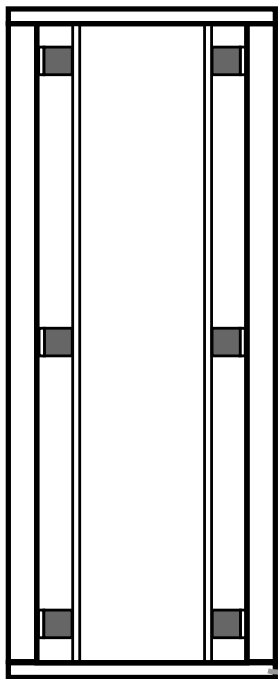

IF YOU NEED TO ELEVATE THE DOOR YOU CAN USE THE HINGES NUMBER 9 AND PLACE THEM ON THE BOTTOM BOLT

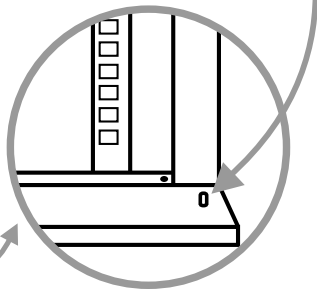
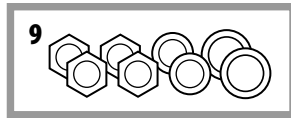

PULL THE BOLT DOWNWARDS TO INSTALL THE DOOR

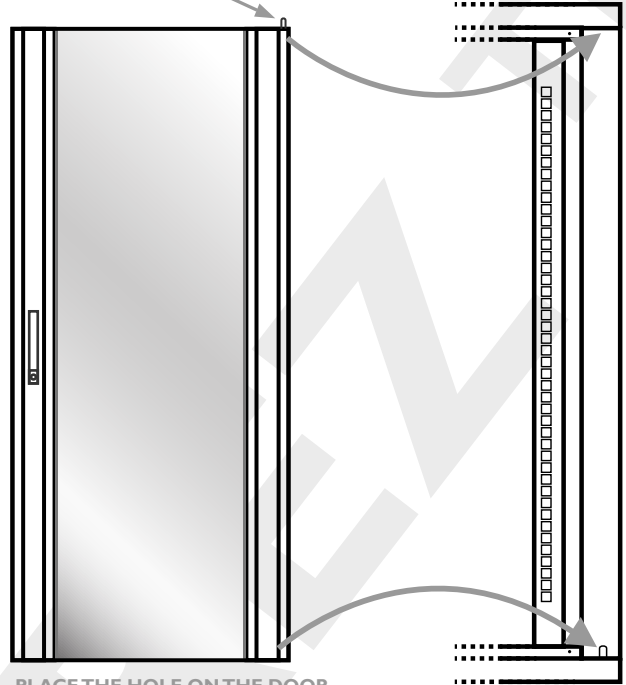

PLACE THE HOLE ON THE DOOR INSIDE THE BOTTOM BOLT

STEP 6

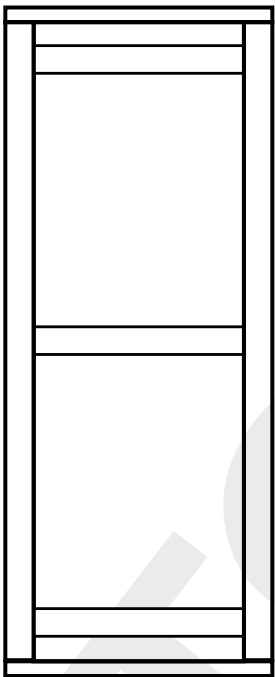

SIDEVIEW

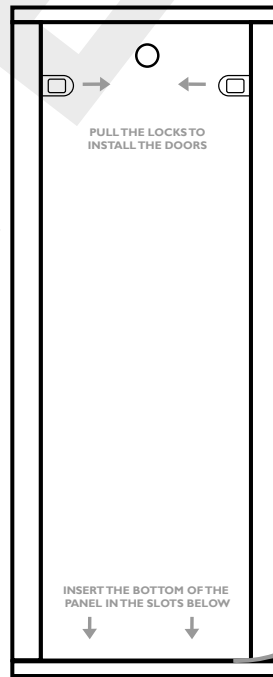

REPEAT THIS ACTION FOR THE OTHER SIDE

PULL THE LOCKS TO INSTALL THE DOORS

INSERT THE BOTTOM OF THE PANEL IN THE SLOTS BELOW

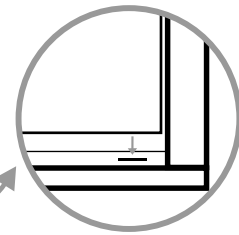

STEP 7

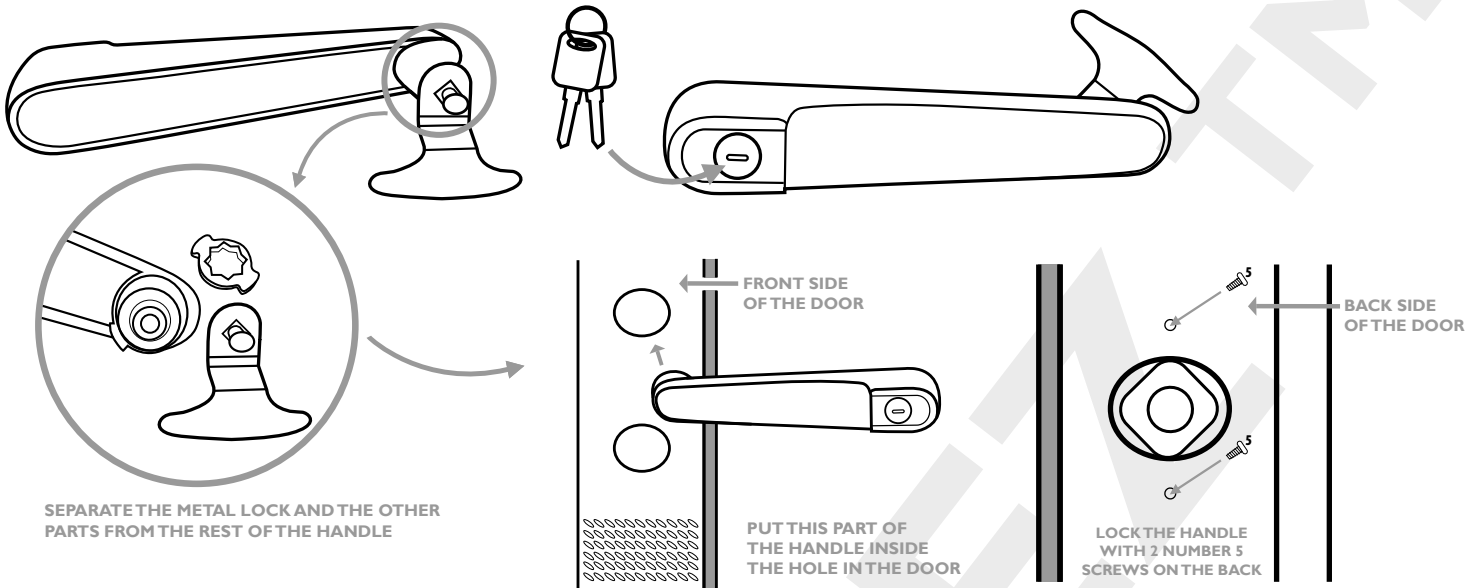

STEP 8

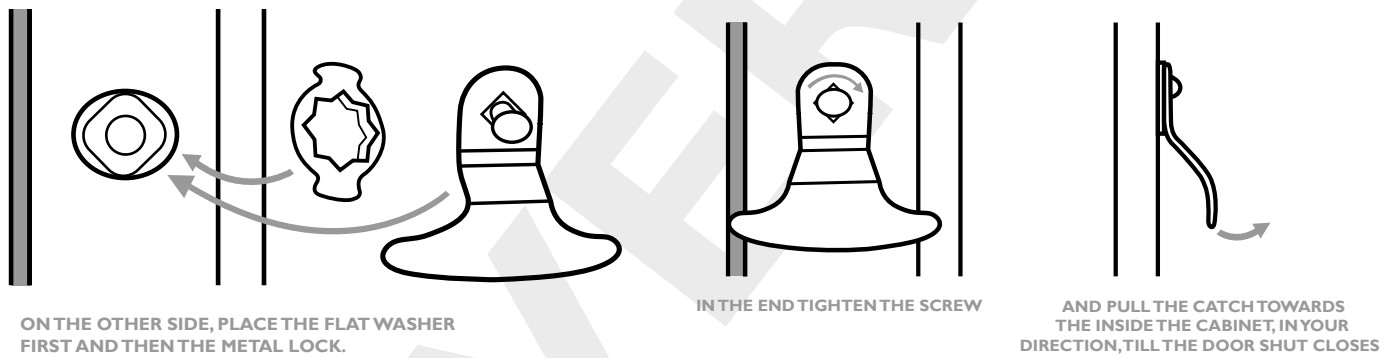

STEP 9

IN THE END YOU CAN ATTACH THE 4x WHEELS OR 4x ADJUSTMENT FEET ON THE BOTTOM COVER

